



INSTALLATION INSTRUCTIONS FOR PART 99-7605

APPLICATIONS
INFINITI G35 Coupe 2005-07
INFINITI G35 Sedan 2005-06
Painted And Finished To Match Factory Dash

99-7605

KIT FEATURES

- ISO Mount Radio Provision



KIT COMPONENTS

A) Radio Housing B) Climate Control Cable

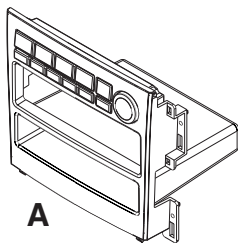

A



B

TOOLS REQUIRED:

Small Flat Blade Screwdriver/ Panel Removal Tool

- Phillips Screwdriver • Hook Tool



1-800-221-0932



www.metraonline.com

© COPYRIGHT 2008 METRA ELECTRONICS CORPORATION



TABLE OF CONTENTS

Dash Disassembly

- Infiniti G35 Coupe 2005-2007/G35 Sedan 2005-06.....1,2

Kit Assembly

ISO Mount Radio Provision3

Final Assembly4

***Note:**

Refer also to the instructions included with the aftermarket radio.

INFINITI G35 Coupe 2005-07 / INFINITI G35 Sedan 2005-06

- 1 Disconnect the negative battery terminal to prevent an accidental short circuit.
- 2 Push down on the collar below the shift knob to unclip. Using a small screwdriver or hook tool remove the spring clip to release and remove the shift knob. **(Figure A)**
- 3 Unclip and remove the shifter trim panel including the ashtray/cigarette lighter. **(Figure B)**
- 4 Remove (2) Phillips screws (exposed under the trim panel removed in step 3) from the panels on the left and right side of the radio/climate control panel assembly. **(Figure C)**
- 5 Unclip and remove the trim panels on the left and right side of the radio/climate control panel assembly. **(Figure D)**
- 6 Unclip and remove the thin plastic trim piece at top edge of dash. **(Figure E)**
- 7 Unclip and remove the hood panel above the clock on the top of the dash. **(Figure F)**

Continued on page 2.

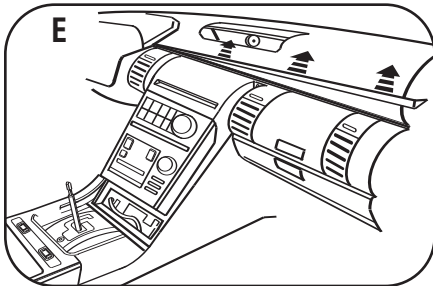
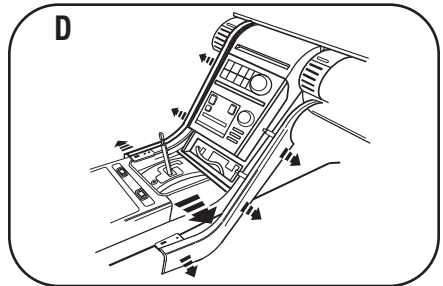
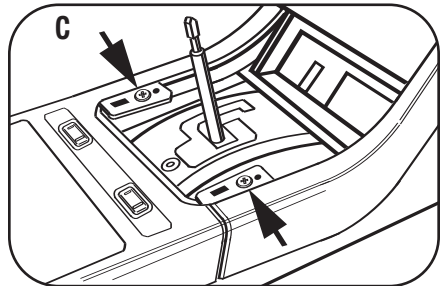
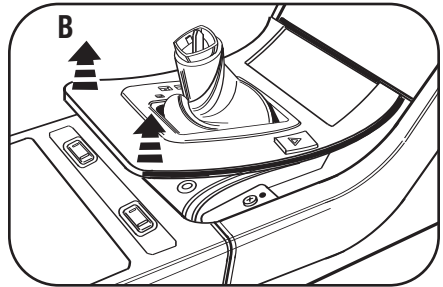
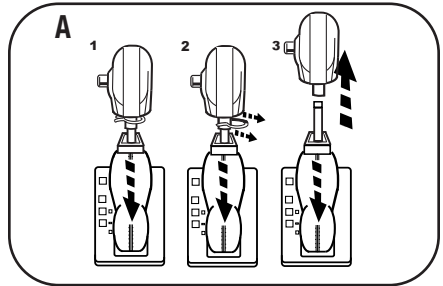

INFINITI G35 Coupe 2005-07 / INFINITI G35 Sedan 2005-06

8 Unclip and remove the trim panel at the bottom of the clock panel then remove the (1) Phillips screw exposed below it. **(Figure G)**

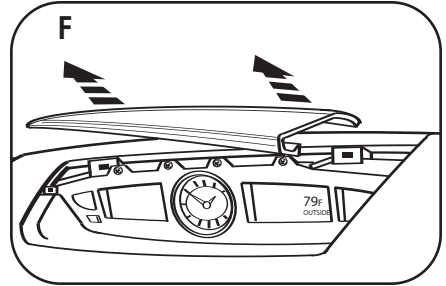

9 Remove (2) Phillips screws below the radio/climate control panel and (2) Phillips screws at the top of the radio/climate control panel assembly (between the a/c vents). **(Figure H)**

10 Unclip the radio/climate control panel/factory bracket. Unplug and remove the assembly. **(Figure H)**

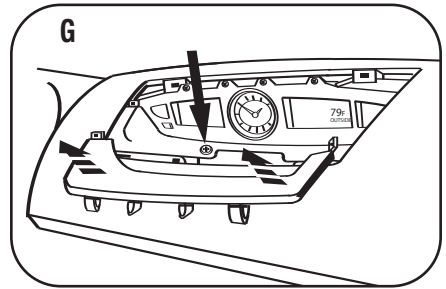

11 Unclip the ribbon cable joining the radio/climate control panel to the radio chassis. **(Figure I)**

12 Remove (8) Phillips screws securing the radio chassis and (6) Phillips screws securing the radio/climate control panel to the factory bracket assembly. Save screws and bracket for re-use during kit assembly. **(Figure J,K)**

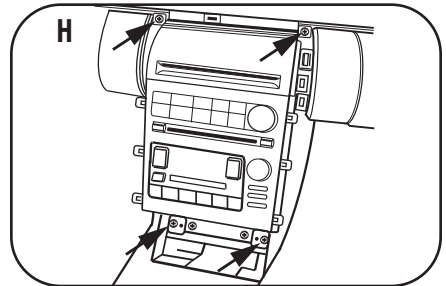

Continue to kit assembly.

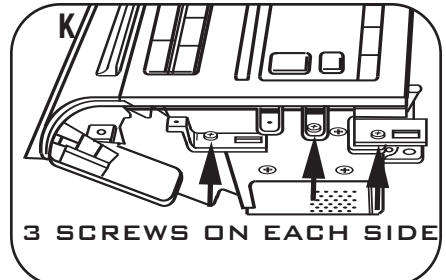
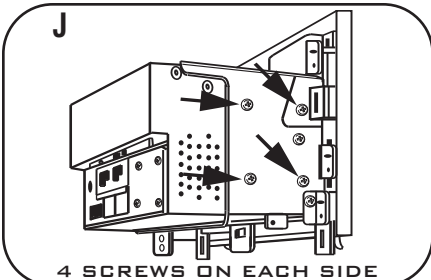
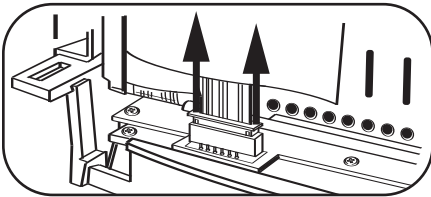

ISO MOUNT RADIO PROVISION

**Note: Refer also to the instructions included with the aftermarket radio.*

- 1** Position the radio into the factory bracket assembly and secure with the screws supplied with the aftermarket radio. (Figure A)
- 2** Attach the radio housing to the factory bracket assembly using the factory hardware. (Figure B)
- 3** Connect the black end of the climate control cable to the climate controls in the radio housing and connect the other end of the cable to the factory climate control harness during final assembly.

Continue to final assembly.

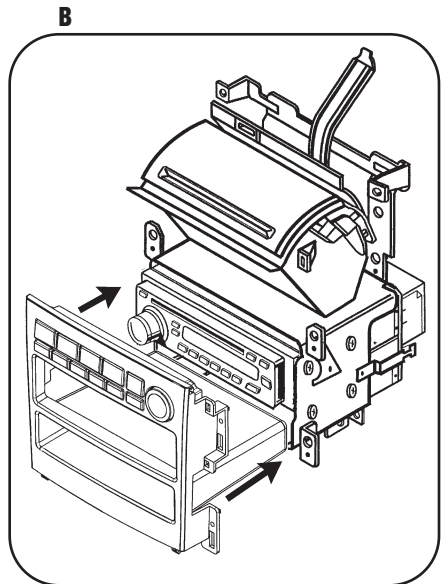
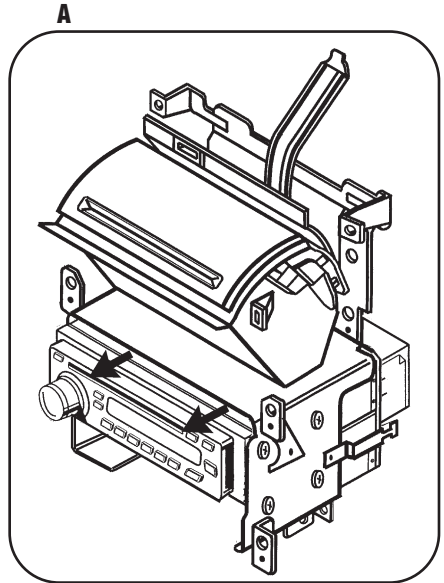



FINAL ASSEMBLY

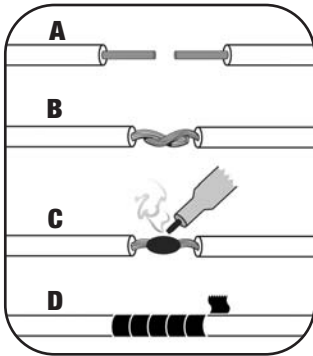

- (A) Strip wire ends back 1/2"**
- B) Twist ends together**
- C) Solder**
- D) Tape**

- 1** Locate the factory wiring harness in the dash. Metra recommends using the proper mating adapter and making connections as shown. (Isolate and individually tape off the ends of any unused wires to prevent electrical short circuit.)
- 2** Re-connect the negative battery terminal and test the unit for proper operation.
- 3** Reassemble radio and dash assemblies in reverse order of disassembly.

FINAL WIRING CONNECTIONS

Make wiring connections using the EIA color code chart shown below and the instructions included with the head unit. Metra recommends making connections as shown below; Strip, Splice, Solder, Tape. Isolate and individually tape off ends of any unused wires to prevent electrical short circuit.

METRA / EIA WIRING CODE

| | | | |
|-----------------------------|----------------|---------------------------|----------------|
| 12V Ignition / Acc. | Red | Right Front (+) | Gray |
| 12V Batt / Memory. | Yellow | Right Front (-). | Gray/ Black |
| Ground. | Black* | Left Front (+) | White |
| Power Antenna. | Blue | Left Front (-). | White / Black |
| Amp Turn-On | Blue / White | Right Rear (+) | Violet |
| Amp Ground. | Black / White | Right Rear (-). | Violet / Black |
| Illumination | Orange | Left Rear (+) | Green |
| Dimmer | Orange / White | Left Rear (-) | Green / Black |

***NOTE:** When a Black wire is not present, ground radio to vehicle chassis.
All colors may not be present on all leads due to manufacturer's specifications.

99-7605 INSTRUCTIONS



1-800-221-0932



www.metraonline.com

REV. 05/30/08 © COPYRIGHT 2008 METRA ELECTRONICS CORPORATION INST99-7605