



Ambient car lighting kit 18

LED lights with 5 controllers

Visit [HeiseLED.com](https://www.HeiseLED.com) to view the available installation parts and accessories.

Watch a Complete Installation of this product on: [youtube.com](https://www.youtube.com)



Part Components

- (1) 3ft Chase LED ambient mini strips with 3ft cable
- (4) 2.5ft Chase LED ambient mini strips with 3ft cable
- (1) 1ft Chase LED ambient mini strips with 3ft cable
- (4) Foot well accent light
- (4) Door handle accent light
- (4) Door pocket accent light
- (5) Heise Connect chase controller
- (1) RF remote
- (12) 6.5ft extension cables
- (2) Y adapter cables
- (5) Adhesive pad
- (6) Cable ties

Tools Needed

- Panel pry tool
- Marker
- Scissors
- Wire stripper
- Crimper
- Screw drivers
- Socket set
- Drill
- 11/32 drill bit
- Electrical tape
- Glue

Table of Contents

• Dash Controller Installation 2
• Dash Ambient Strip Installation 6
• Foot Well Accent Installation 15
• Door Controller Installation 22
• Door Ambient Strip Installation 28
• Door Handle Accent Option 1 36
• Door Handle Accent Option 2 42
• Door Pocket Accent Installation 48

What's in the box:

(A) Adhesive pads (B) Cable ties, (C) Heise connect controllers and remote, (D) Ambient LED strips and accent lights, (E) Extension cables and Y adapters

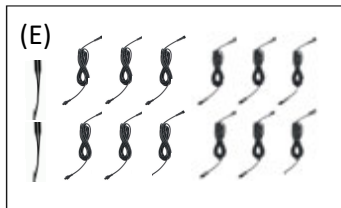
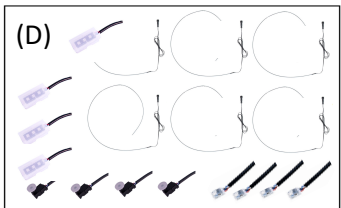
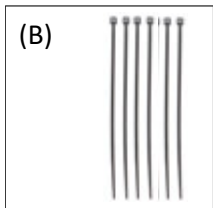

Dash Controller Installation

This section uses:

- (1) Chase controller



- Find a suitable and safe location to mount the controller. Typically, good locations can be found under the driver's side of the dash. Clean the location with rubbing alcohol and let dry. Then, apply the double sided pad to the rear of the controller and stick in place.



- Locate the power connections cable on the controller. The red wire should be fused (10A) and connected to a switched power source. We recommend connecting an add-a-fuse adapter (not included) that matches the vehicles fuse type, to the red wire and connecting to a switched circuit in the dash fuse box (15A or greater). A service manual can assist in identifying. The black wire should be connected to a factory chassis ground point. This can generally be found in the driver kick panel.

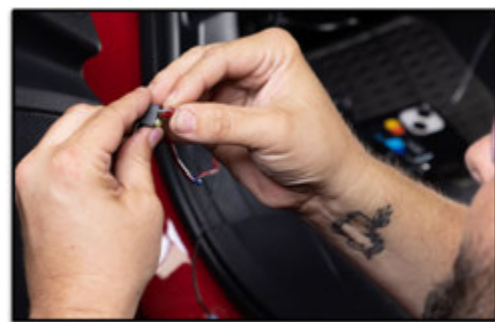
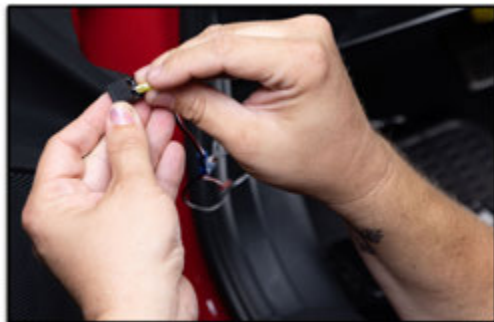

***Add-a-fuse part numbers**

ATC fuse: ATCDT-1

ATR fuse: ATRDT-1

ATM Mini fuse: ATMDT-1

ATM Low Profile fuse: ATMLPDT-1

***Recommended tools**

InstallBay part number: HW-9013

InstallBay part number: IBJ1005



NOTE: Set pixel count to 80

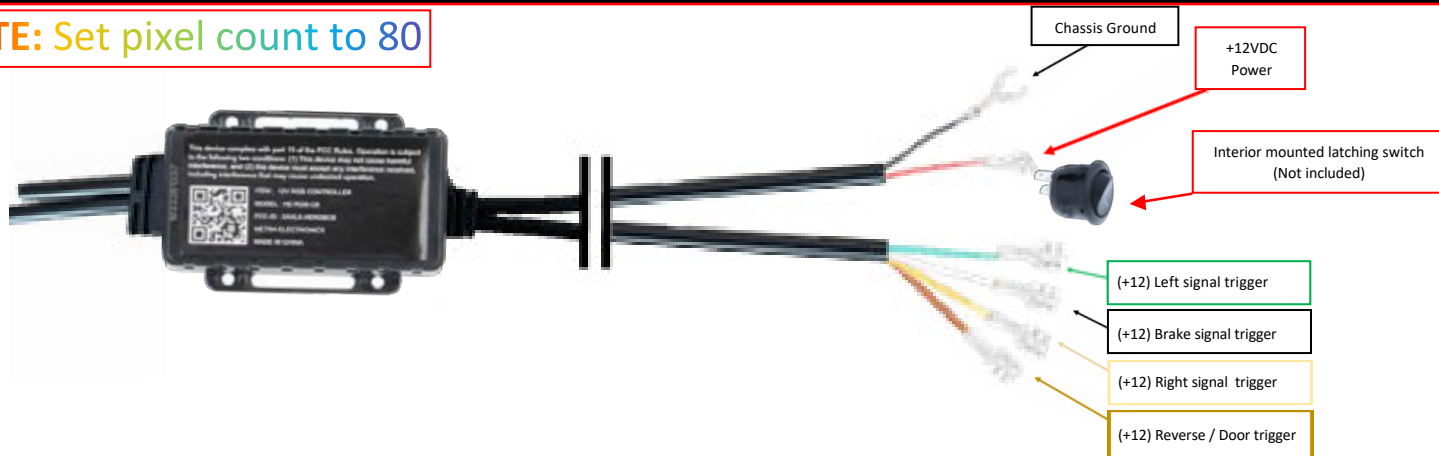

We're excited to see your installs, scan the QR to share on our Instagram.



Dash Ambient Strip Installation



This section uses:

- (1) 3ft strip (passenger side)
- (1) 1ft strip (driver side)

Notes before installing

- Do not cut the 3 wire cable on the strip, as the wires are not marked. This makes it easy to cross wires when reattaching, which will cause immediate failure of the strip.



- Strips can be bent around shapes without issue. Extreme bends can be made as well, but will require careful installation.

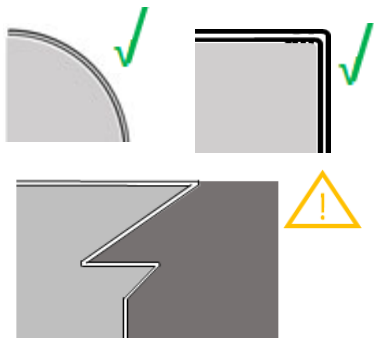

- The mini strip will only flex perpendicular to the light pipe.

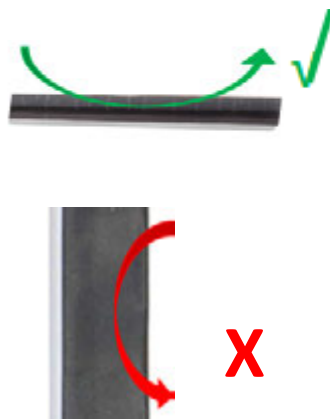

- When installing the mini strips, only apply pressure to the exposed light pipe. Applying force to the taped area may cause damage to the LEDs under the tape.

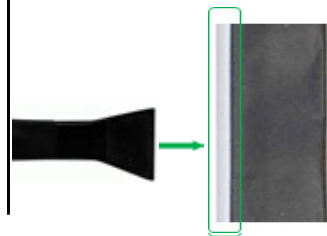

- Find locations to install the strips. Good locations have these attributes:
 - Not in the driver line of sight
 - Area is flexible
 - Gap large enough to fit strip (strip is 3/32" thick and 3/16" deep)



- Position the strip over the desired location in the orientation that the strip will be installed. Make sure to allow for the wires connecting to the strip, so that they will not be pinched or stressed.



- Using a marker (silver color works well), mark the point where the strip needs to be cut to fit the location. Be careful not to mark the vehicle in the process. Also, make note if a straight cut or angled cut would be a better fit. If making an angled cut, mark the angle on the strip. With a pair of scissors, cut the strip as marked.



Straight cut



Angled cut

- Position the cut strip in the location as it was previously. Beginning at that start of the strip (wire end), press the strip into the gap. Using a pry tool to spread the panels will assist in setting the strip. Pressure can be applied with the pry tool to the light pipe. Be careful not to stress the strip during this process. Once the strip is set, use the same technique to tuck the strip's wire.



*Recommended tool

InstallBay part number: ATH52NGL



- Route the strip wires to the controller. Depending on the location that the controller was mounted, an extension cable may be needed to cover the distance of the run (not included). Be mindful routing the wires, avoid moving components and hot surfaces.



- Locate the output connectors on the controller, and find the arrows marked on the heads. Align the arrow on the strip wire head with the arrow on the output head. Connect the strip on the driver's side to either of the "left output" connectors, and the strip on passenger's side to either of the "right output" connectors. To connect press the heads together firmly, then screw the retaining cap clockwise.



- Switch on vehicle, and test functionality.



Foot Well Pod Installation

This section uses:

- (4) LED pods
- (4) 6.5ft extension cables
- (2) Y adapter cables

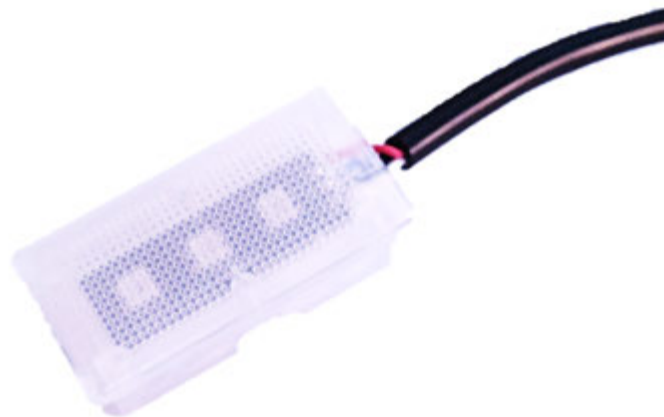

- Start by locating the crossbar under the passenger front seat. The crossbar is part of the seat frame, and will move when the seat is slid forwards and backwards. Position one LED pod against the crossbar with the LEDs facing towards the rear of the vehicle. Secure the tube to the crossbar with a cable tie.

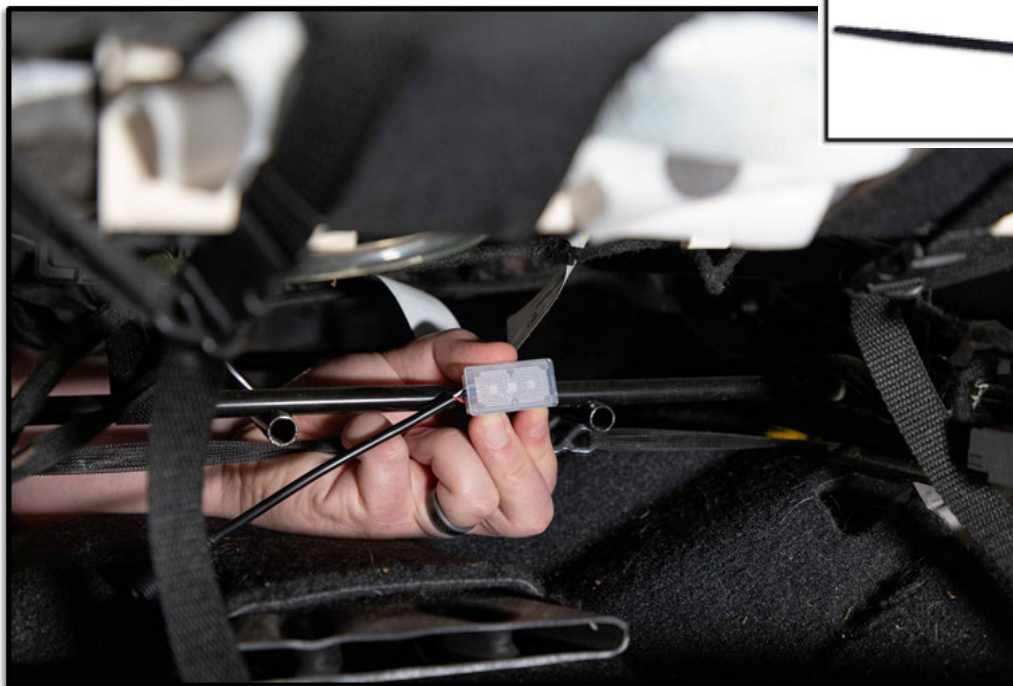

- Use one 6.5ft extension cable, and align the arrow on the extension cable head with the arrow on the cable head of the installed LED pad. To connect press the heads together firmly, then screw the retaining cap clockwise.



- Remove the seal plate from the vehicle. Lift the carpet and route the extension cable under the carpet and out into the door seal area.



- Tuck the extension under the carpet, working your way along the door seal and up to the kick panel. Then, tuck the extension cable up and behind the kick panel.
- Continue routing the extension cable to the dash mounted controller.



- Find a safe location to mount one LED pod under the passenger side of the dash. It can be mounted to a panel with double sided tape or secured to a factory harness with a cable tie. The pod should be orientated with the LEDs pointed down into the foot well. Connect one 6.5ft extension cable to the pod and route cable to the dash mounted controller. Secure any excess cable.



- Repeat under seat and under dash pod installation for driver side.

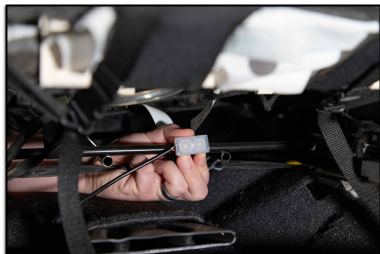

*Recommended tape
InstallBay part number: IB4965



- Connect one Y adapter to the open "Left" output, and connect one Y adapter to the open "Right" output on the controller. Connect the driver side pod extension cables to the "Left" Y adapter, and connect the passenger side pod extension cables to the "Right" Y adapter.



- Switch on vehicle, and test functionality.



Door Controller Installation

This section uses:

- (4) Chase controllers (one per door)



- Look up door disassembly for the vehicle. This information can be found in a service manual. Follow the guide and remove the door panels.



- Find a suitable and safe location to mount the controller. Verify that the chosen location will not interfere with re-installation of the door panel. Clean the location with rubbing alcohol and let dry. Then, apply the double sided pad to the rear of the controller and stick in place. Repeat for all doors.



- Locate the controller power connections. The black wire should be connected to a factory chassis ground point. Factory bolts inside the door generally will suffice. A multimeter should be used to check the ground continuity.



*Recommended tool
InstallBay part number: 3320



- The red wire should have a 10A fuse (sold separately) and should be connected to a switched power source. You can refer to a service manual to identify if there is a suitable circuit available in the door, and if so, determine the wire color and location. A multimeter (DCV setting) should be used to confirm the wire. Connect the red probe to the wire in question and the black probe to the ground located in the last step. Turn the key to the run position. The meter should go from 0 to 12V, then back to 0 when the key is turned to the off position.
- If a suitable circuit can not be found, move on to the second wiring option.

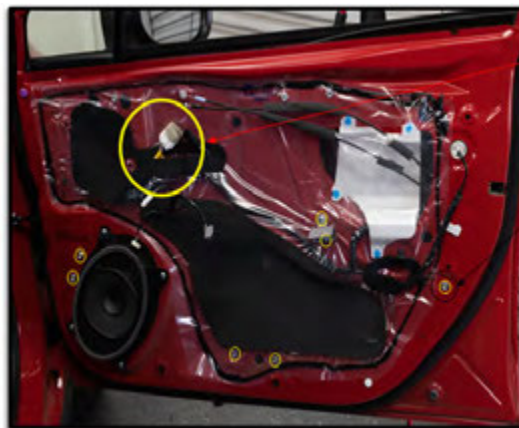

- For the second wiring option, you will need to extend the red wire and route it into the cabin. We recommend using an add-a-fuse adapter (not included) that matches your vehicle's fuse type, and connecting it to a switched circuit in the dash fuse box with a rating of 15A or higher. A service manual can be helpful in identifying an appropriate circuit.

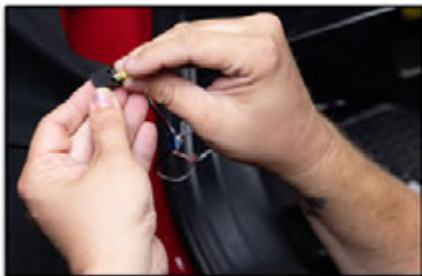
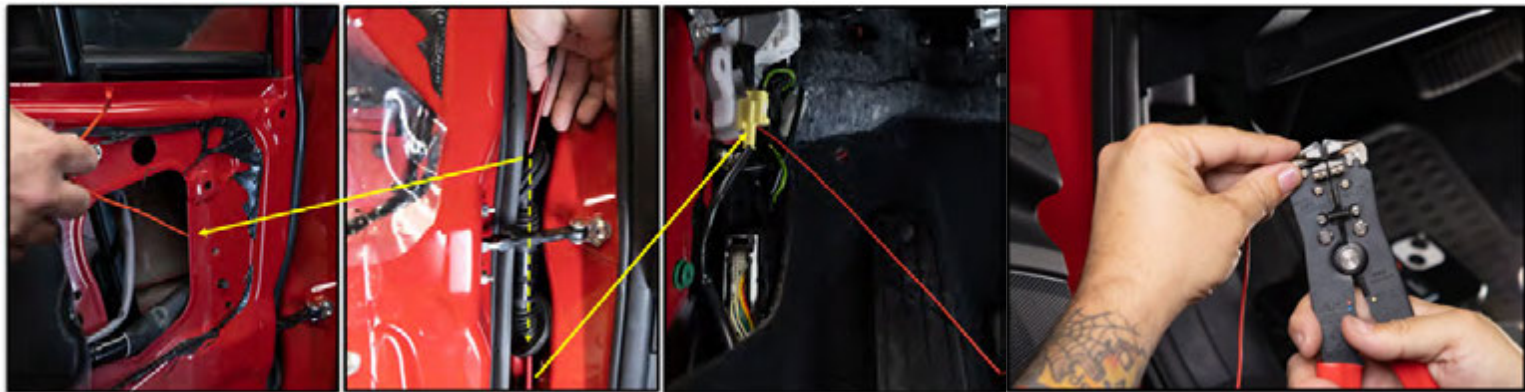

***Add-a-fuse part numbers**

- ATC fuse: ATCDT-1
- ATR fuse: ATRD-1
- ATM Mini fuse: ATMDT-1
- ATM Low Profile fuse: ATMLPDT-1

- Repeat for remaining doors.

NOTE: Set pixel count to 67

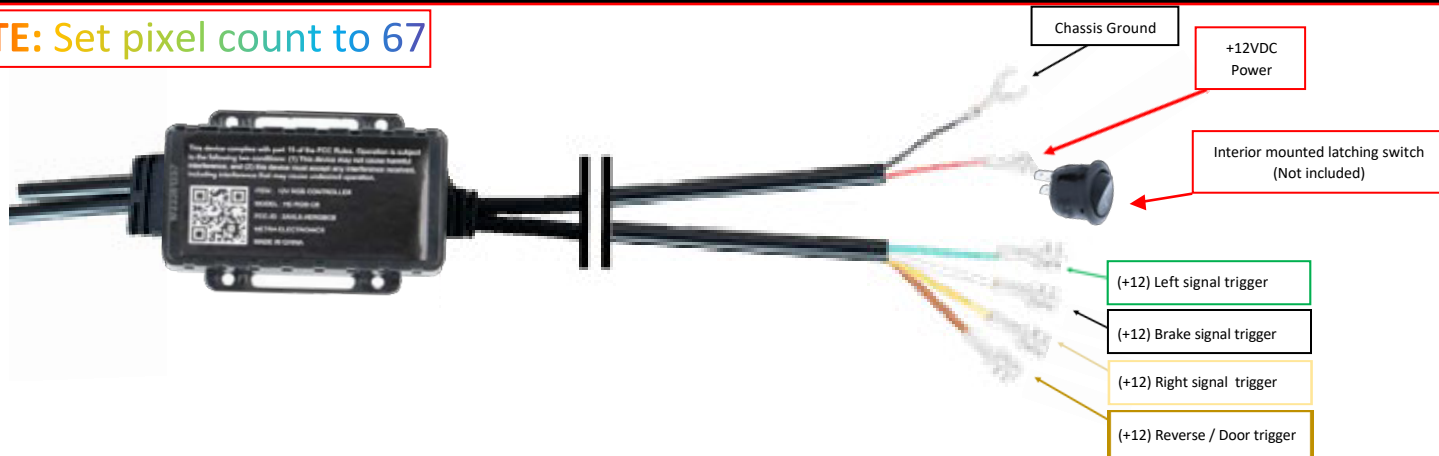

We're excited to see your installs, scan the QR to share on our Instagram.

Door Ambiement Strip Installation

This section uses:

- (4) 2.5ft Ambient Strips (one per door)



Notes before installing

- Do not cut the 3 wire cable on the strip, as the wires are not marked. This makes it easy to cross wires when reattaching, which will cause immediate failure of the strip.



- Strips can be bent around shapes without issue. Extreme bends can be made as well, but will require careful installation.

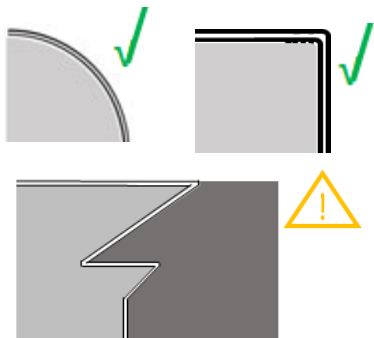

- The mini strip will only flex perpendicular to the light pipe.

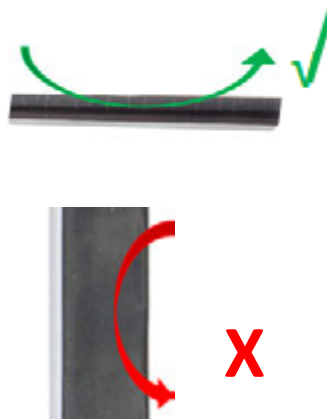

- When installing the mini strips, only apply pressure to the exposed light pipe. Applying force to the taped area may cause damage to the LEDs under the tape.

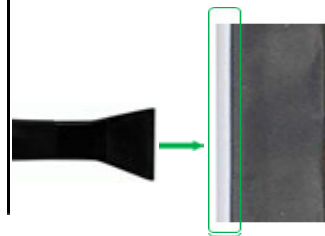

- Find locations to install the strips. Good locations have these attributes:
 - Not in the driver line of sight
 - Area is flexible
 - Gap large enough to fit strip (strip is 3/32" thick and 3/16" deep)

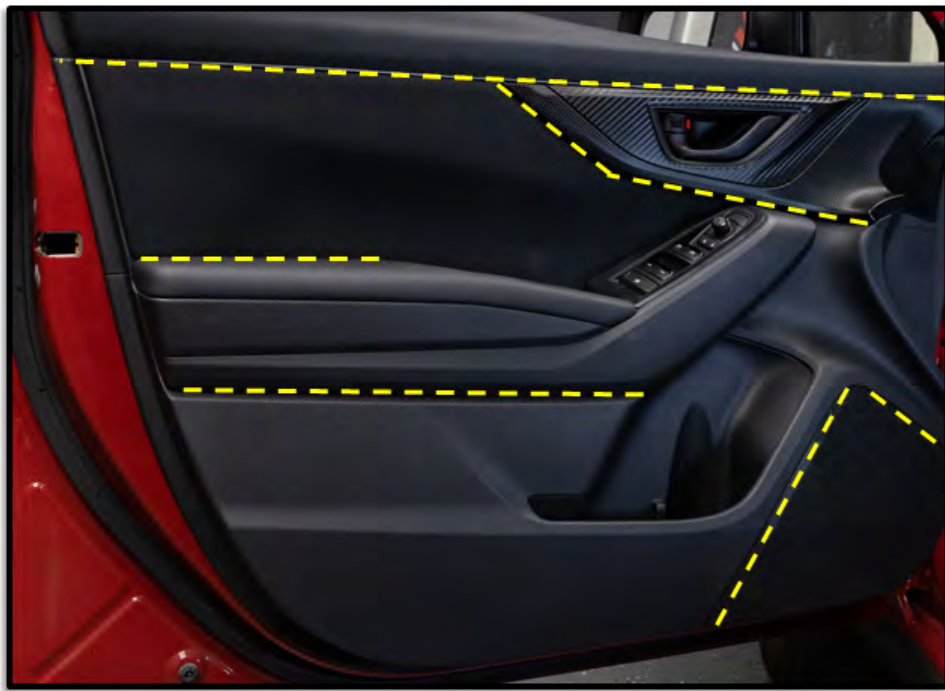

*Note, one piece door panels found on many modern vehicles will not allow the press fit installation, as shown in this guide. These types of door panels can be done but will require custom modifications that should be performed by a trained professional.



(example of one piece panel)

- Inspect the door panel and determine how to route the wire from the front of the panel to the rear of the panel. Look for seams, gaps, and layered panels. You may need to feed the strip through a gap, from the rear of the panel to the front, instead of trying to route the connector head through the panel. If no existing option is available for routing the wire from the strip location, then a hidden hole (5/16") will need to be drilled in the panel. Sometimes, an alternate location from the original ideal for the strip will provide a better installation and finished product.



- Once the location and routing has been determined, position the strip over the desired location in the orientation that the strip will be installed. Make sure that to allow for the wires connecting to the strip, so that they will not be pinched or stressed.
- Using a marker (silver color works well), mark the point where the strip needs to be cut to fit the location. Be careful not to mark the vehicle in the process. Also, make note if a straight cut or angled cut would be a better fit. If making an angled cut, mark the angle on the strip. With a pair of scissors, cut the strip as marked.

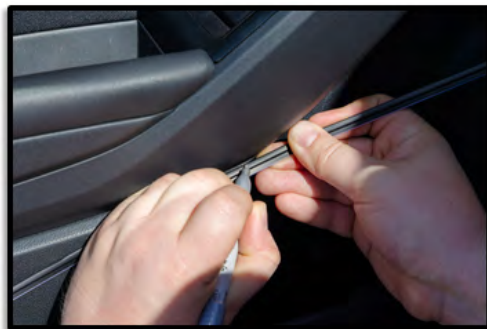
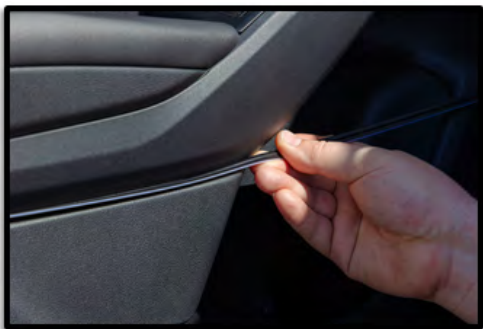

- Install the cut strip, route the strip through the panel first if needed. Position the cut strip in the location as it was previously. Beginning at that start of the strip (wire end), press the strip into the gap. Using a pry tool to spread the panels will assist in setting the strip. Pressure can be applied with the pry tool to the light pipe. Be careful not to stress the strip during this process. Once the strip is set, use the same technique to tuck the strip's wire.



- Locate the output connectors on the controller, and find the arrows marked on the heads. Align the arrow on the strip wire head with the arrow on any of the output heads. To connect press the heads together firmly, then screw the retaining cap clockwise.



- Switch on vehicle, and test functionality.
- Repeat for remaining doors.



Door Handle Accent LED Installation

This section uses:

- (4) Door handle accent LEDs
- (4) 6.5ft extension cables



Option 1: Custom mounting

- Locate a place for the LED handle light inside the door handle pocket. The location should be a flat surface, not directly visible, and not interfere with handle functions or re-installation of the door panel.



- Locate the desired location on the rear of the door panel. Using a drill and 11/32 drill bit, make a hole at the location. Go slow to prevent drilling too deep and marring the door handle.

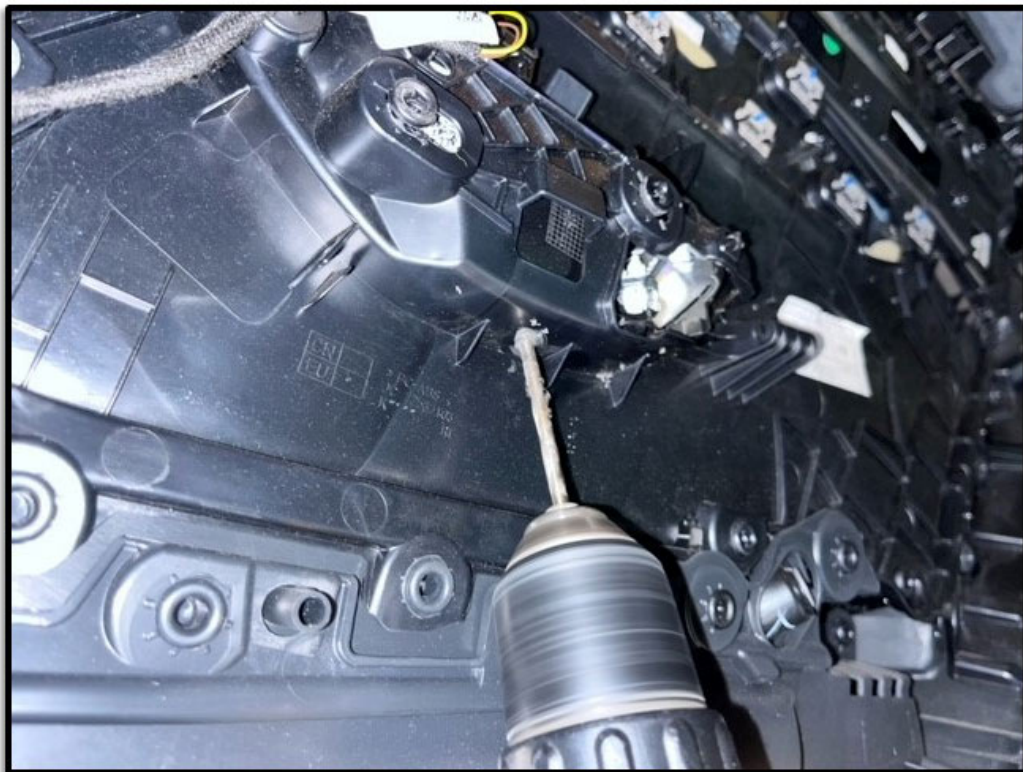

- Take one handle light and apply double-sided tape below the stem. Then, insert the stem into the hole from the back side of the panel. The double -sided tape will hold the light head in place.



*Recommended tape

InstallBay part number: IB4965



- Use one 6.5ft extension cable, and align the arrow on the extension cable head with the arrow on the cable head of the installed LED handle light. To connect press the heads together firmly, then screw the retaining cap clockwise. Connect the other end of the extension cable to an output connector on the door controller.



- Switch on vehicle, and test functionality.
- Repeat for remaining doors.



Door Handle Accent LED Installation

This section uses:

- (4) Door handle accent LEDs
- (4) 6.5ft extension cables



Option 2: OE mounting

- If the panel has an existing light or light pipe, the hole or pipe may be modifiable to allow for the new light head to integrate with it.



- Make any needed modifications, then take one handle light and apply double-sided tape below the stem. Mount the handle light. The double-sided tape will hold the light head in place.

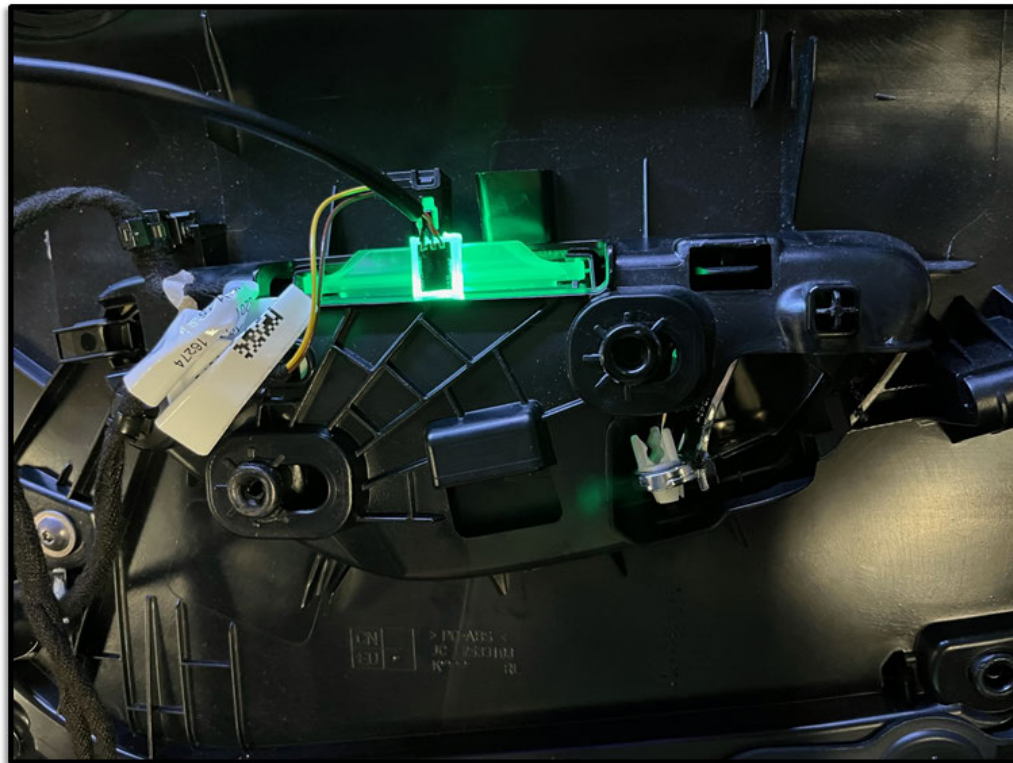

*Recommended tape

InstallBay part number: IB4965



- Use one 6.5ft extension cable, and align the arrow on the extension cable head with the arrow on the cable head of the installed LED handle light. To connect press the heads together firmly, then screw the retaining cap clockwise. Connect the other end of the extension cable to an output connector on the door controller.



- Switch on vehicle, and test functionality.
- Repeat for remaining doors.



Door Pocket Accent LED Installation



This section uses:

- (4) Door pocket accent LEDs
- (4) 6.5ft extension cables

- Locate a place for the LED pocket light inside the door pocket. The location should be a flat surface, low enough not to be directly visible, and not interfere with pocket functions or re-installation of the door panel.



- Locate the desired location on the rear of the door panel. Using a drill and 11/32 drill bit, make a hole at the location. Go slow to prevent drilling too deep and marring the outer pocket wall.

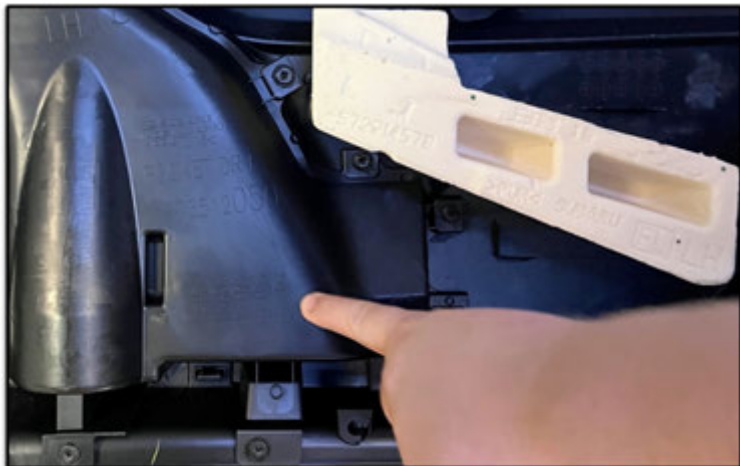

- Take one pocket light and pull the clear plug out of the light head. Place a few small drops of glue at the base of the stem, then insert the stem into the hole from the pocket side of the panel.

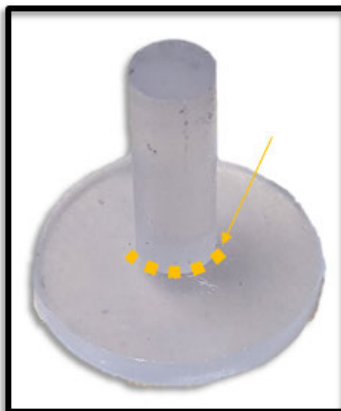

*Recommended glue

InstallBay part number: MAXI-CURE1



- While keeping pressure on the face of the plug (pocket side), press the light head back onto the plug stem from the rear of the panel.



- Use one 6.5ft extension cable, and align the arrow on the extension cable head with the arrow on the cable head of the installed LED pocket light. To connect press the heads together firmly, then screw the retaining cap clockwise. Connect the other end of the extension cable to an output connector on the door controller.



- Switch on vehicle, and test functionality.
- Repeat for remaining doors.

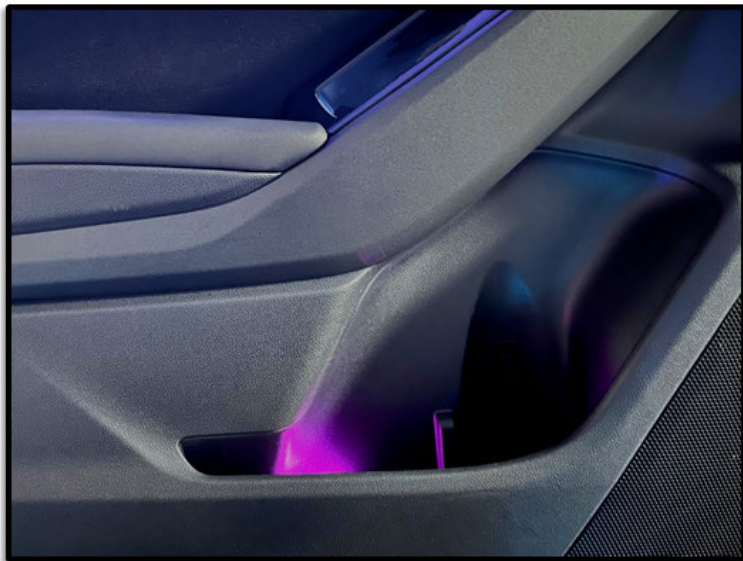

- Installation of the kit is now complete. Reassemble all removed panels.

IMPORTANT: Document date of purchase, and place of purchase.

Date: _____

Place of Purchase: _____

Install Notes: _____

A large rectangular area with a thick red border, containing ten horizontal black lines for writing instructions.



Thank you for purchasing from Metra Electronics! We're excited to see your installs, scan the QR to share on our Instagram. If you have any questions, comments, feedback on the product, please contact our tech support email via techsupport@metra-autosound.com.

Don't forget to Visit [HeiseLED.com](https://www.HeiseLED.com) to view the available installation parts and accessories.

Having difficulties?

Contact our tech support line at:
Techsupport@metra-autosound.com

Or via phone at:
368.257.1187

TECH SUPPORT HOURS (EST)

Monday-Friday: 9:00AM – 7:00PM
Saturday: 10:00AM – 5:00PM Sunday:
10:00AM – 4:00PM

Closed for most US Federal Holidays



Metra Recommends MECP
certified technicians