

SHURIKEN® POWER SPORTS

SK-BTX9-BS [12V8Ah]

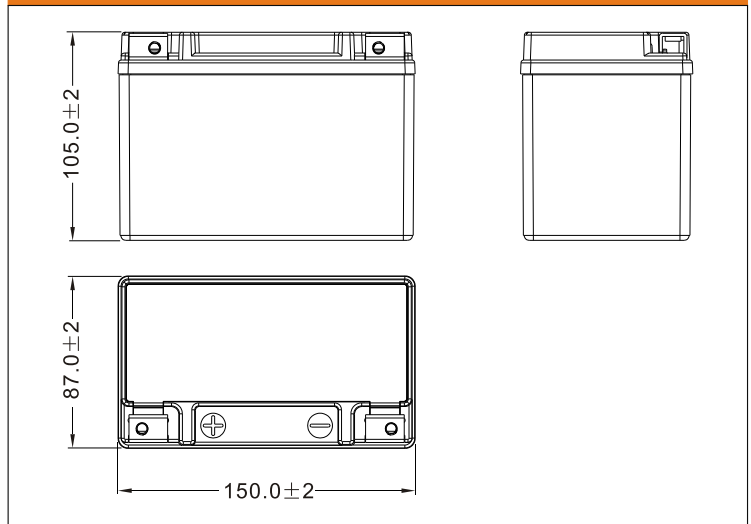

Dimensions (mm)



Standard Terminal (mm)

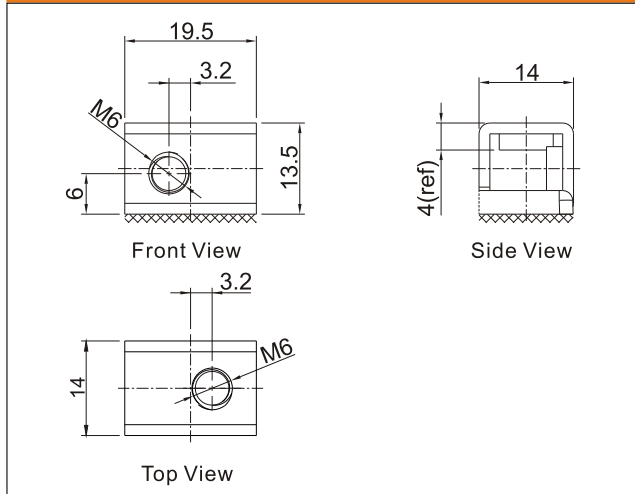

Physical Specification

Nominal Voltage		12V
Nominal Capacity (10HR)		8AH
Dimension	Length	150 ± 2mm (5.91 inches)
	Width	87 ± 2mm (3.43 inches)
	Container Height	105 ± 2mm (4.13 inches)
	Total Height (with Terminal)	105 ± 2mm (4.13 inches)
Weight	Battery(with acid):	Approx 3.05kg (6.73lbs)
	Electrolyte:	Approx 0.6kg (1.32lbs)

- * Sealed and non-spillable AGM battery
- * Maintenance-free
- * Powerful 120 cold cranking amps
- * Shipped pre-charged and ready to install

Discharge Characteristics (25°C, 77°F)

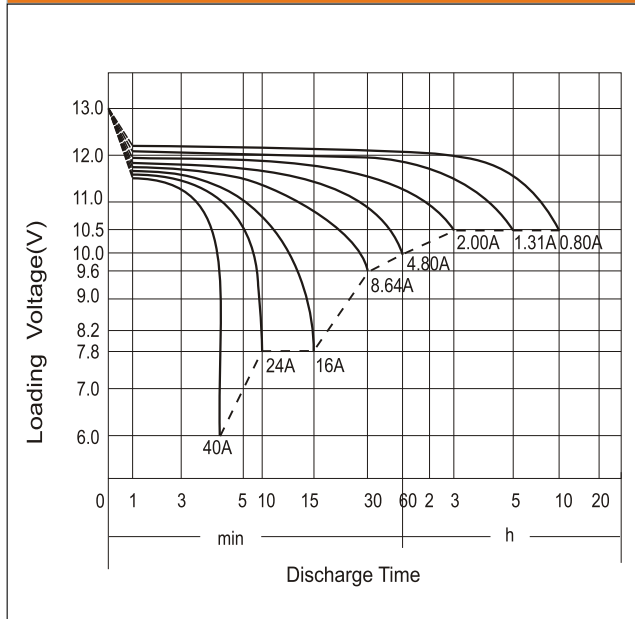

Electrical Specification

Rated Capacity	10 hour rate (0.80 A)	8.00AH
	5 hour rate (1.31 A)	6.56AH
	2 hour rate (2.80 A)	5.60AH
	1 hour rate (4.80 A)	4.80AH
	0.5 hour rate (8.64 A)	4.32AH
Capacity affected by Temperature	40 °C (104 °F)	106%
	25 °C (77 °F)	100%
	0 °C (32 °F)	86%
	-15 °C (5 °F)	65%
Self Discharge	Approximately 3% per month (25°C (77°F))	
Charging Methods	Full Charge	Constant-Voltage Charge: Initial charging current: less than 2.4A Voltage: 14.40 V ~ 15.00 V at 25 °C (77 °F) Charging time: 15 ~18h Constant-Current Charge: Charging current: 0.1C ₁₀ =0.80A, when charging voltage up to 14.40V, continue to charge 4h
	Floating Charge	No limit on Initial charging current Voltage: 13.50 V ~ 13.80 V at 25 °C (77 °F)

Sales Office

Metra Electronics
460 Walker Street
Holly Hill, FL 32117-2699
National: 800.221.0932
Local: 386.257.1186
Fax: 800.647.8091

For International Sales:
Maurice.soto@metra-autosound.com
460 Walker Street
Tel: 386-257-1186 ext.2313
Fax: 386.257.9160

For Technical Support:
Techsupport@metra-autosound.com
Tel: 386-257-1187
800.253.TECH (8324)